



HK2216-2RS

Drawn cup needle roller bearing open end

Schaeffler ID:
0007011490968

Drawn cup needle roller bearings with open ends HK..-2RS, lip seals on both sides, to DIN 618

Technical information

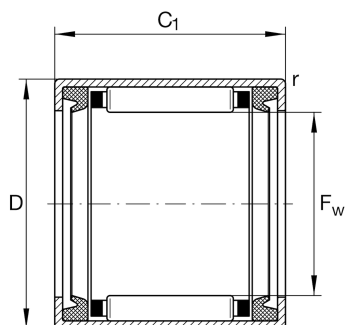

Main Dimensions & Performance Data

F_w	22 mm	Under roller diameter
D	28 mm	Outside diameter
C	16 mm	Width
C_r	9,100 N	Basic dynamic load rating, radial
C_{0r}	13,400 N	Basic static load rating, radial
C_{ur}	1,630 N	Fatigue load limit, radial
n_G	7,000 1/min	Limiting speed
$n_{G \text{ Grease}}$	7,000 1/min	Limiting speed for grease lubrication
	18.405 g	Weight

Dimensions

C_1	16 mm	Width, outer ring
r_{\min}	0.8 mm	Minimum chamfer dimension
	IR17X22X16-XL	Suitable inner rings IR

Temperature range

T_{\min}	-20 °C	Operating temperature min.
T_{\max}	100 °C	Operating temperature max.